



**Breville®**

# the Oracle™ Jet

BES985

---

 Safety Guide

## CONTENTS

02. Limited product warranty
02. Breville® recommends safety first
07. Components
08. Accessories
09. Unboxing
09. Care and cleaning
10. Hopper assembly
10. Water filter assembly
11. Setting water hardness
12. First use flush cycle
13. Make a coffee
15. Grind coarser or finer
16. Texture milk
17. QR code web access

## LIMITED PRODUCT WARRANTY

### 2 YEAR LIMITED

Breville's warranty for this product covers the repair or replacement if it's found to be defective due to faulty materials, workmanship, or function within the warranty period.

All legal warranty rights under applicable national legislation will be respected and will not be impaired by our warranty. For details on length of warranty, to obtain a printed copy or to read full terms and conditions please scan the QR code or visit [www.breville.com](http://www.breville.com). Alternatively, call the Breville Service Centre (see back cover for contact details)



QR149

## BREVILLE® RECOMMENDS SAFETY FIRST

**At Breville® we are very safety conscious. We design and manufacture consumer products with the safety of you, our valued customer, foremost in mind. In addition, we ask that you exercise a degree of care when using any electrical appliance and adhere to the following precautions.**

## IMPORTANT SAFEGUARDS

**Read all instructions before use and save for future reference.**

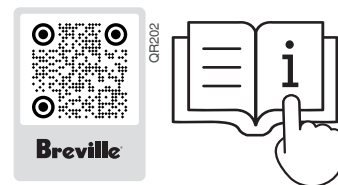

- A downloadable user guide is available at [breville.com](http://breville.com)
- Remove and discard any packaging materials safely before use.
- Ensure the product is properly assembled before use and fully unwind the power cord before operating.
- Before using for the first time, please ensure that your electricity supply is the same as shown on the rating label on the underside of the appliance. If you have any concerns, please contact your local electricity company.
- The installation of a residual current safety switch is

recommended to provide additional safety when using all electrical appliances. Safety switches with a rated operating current not more than 30mA are recommended. Consult an electrician for professional advice.

- Regularly inspect the power cord, plug and appliance for any damage. If found to be damaged in any way, immediately cease use of the appliance, and return the entire appliance to the nearest authorised Breville Service Centre for examination, replacement, or repair.
- Do not let the power cord hang over the edge of a counter or table. Do not let the power cord touch hot surfaces or become knotted.
- Do not touch hot surfaces. Always ensure the appliance has been allowed to cool;

if the appliance is to be: left unattended, cleaned, moved, assembled, or stored, always switch off the espresso machine by pressing the POWER button to OFF. Switch off and unplug from the power outlet.

- Children must not play with the appliance. Do not leave the appliance unattended when in use. Do not move the appliance whilst in operation.
- The appliance is not intended for use by persons (including children) with reduced physical, sensory or mental capabilities, or lack of experience and knowledge, unless they have been given supervision or instruction concerning use of the appliance by a person responsible for their safety. Cleaning and user maintenance shall not be made by children. Keep

the appliance and its cord out of reach of children.

- To eliminate a choking hazard for young children, discard the protective cover fitted to the power plug safely.
- Position the appliance on a stable, heat resistant, level, dry surface away from the counter edge, and do not operate on or near a heat source such as a hot plate, oven, or gas hob.
- Do not operate the appliance in an enclosed space, or inside a cupboard.
- Do not use attachments other than those provided with the appliances. The use of attachments not sold or recommended by Breville may cause fire, electric shock, or injury.
- This appliance is for household use only. Do not use the

appliance for anything other than its intended purpose. Do not use in moving vehicles or boats. Do not use outdoors. Misuse may cause injury.

- Improper use of the appliance, incorrectly operated or unprofessionally repaired will void any warranty claim. No warranty for any damages can be accepted.
- The appliance is not intended to be operated by means of an external timer or separate remote-control system.
- Use caution when operating machine as metal surfaces are liable to get hot during use. Heating element is subject to residual heat after use.
- Do not open the programming port, this is exclusively for authorised service personnel only.
- Do not operate the grinder without the hopper lid in position. Keep fingers, hands, hair, clothing, and utensils away from the hopper during operation.
- Ensure the portafilter is firmly inserted and secured into the group head before starting an extraction. Never remove the portafilter during the extraction process. Failure to follow this instruction may lead to scalding by hot steam or hot coffee.
- Do not fill water tank with hot water.
- The front top fill is not for milk. Do not pour milk in the front top fill.
- Do not use the appliance without water in the water tank.
- Do not fill water tank with hot water or milk.

- Use caution after milk texturing, as the 'Auto Purge' function may purge hot steam when steam wand is lowered.
- Wipe the outer surface with a soft dry cloth. Keep the appliance and accessories clean.
- Servicing other than cleaning should only be performed by an authorised service representative or at an authorised Breville Service Centre.

#### **NOTICE TO CUSTOMERS REGARDING MEMORY STORAGE**

Please note that in order to better serve our customers, internal memory storage has been embedded into your appliance. This memory storage consists of a small chip to collect certain information about your appliance including the

frequency of use of the appliance and the manner in which your appliance is being used. In the event your appliance is returned for service, the information collected from the chip enables us to quickly and efficiently service your appliance.

The information collected also serves as a valuable resource in developing future appliances to better serve the needs of our consumers. The chip does not collect any information regarding the individuals who use the product or the household where the product is used.

If you have any questions regarding the memory storage chip please contact us at [privacy@breville.com](mailto:privacy@breville.com)

## WARNING FOR BUTTON BATTERY



Button battery inside this product



Keep out of reach of children

The battery inside the product shall not be replaced or removed by the user at any time.

- The battery is hazardous and is to be kept away from children (whether the battery is new or used).
- Swallowing battery may lead to serious injury in as little as 2 hours or death, due to chemical burns and potential perforation of the oesophagus.

- If you suspect your child has swallowed or inserted a button battery, immediately seek medical attention, or call the 24-hour Poisons Information Centre on **13 11 26** for fast, expert advice.
- Tell others about the risks associated with button batteries and how to keep their children safe.

Dispose of used button batteries immediately and safely. Flat batteries can still be dangerous.



### WARNING

To avoid the risk of injury, do not open the brew chamber during the brew process.

 To protect against, fire, electric shock; do not immerse the power cord, power plug or appliance in water or any other liquid.

 The symbol shown indicates that this appliance should not be disposed of in normal household waste. It should be taken to a local authority waste collection centre designated for this purpose or to a dealer providing this service. For more information, please contact your local council office.

 **NOTE**

To prevent damage to the appliance, do not use alkaline cleaning agents. Use a clean soft cloth instead.

**SAVE THESE INSTRUCTIONS FOR HOUSEHOLD USE ONLY**



# COMPONENTS

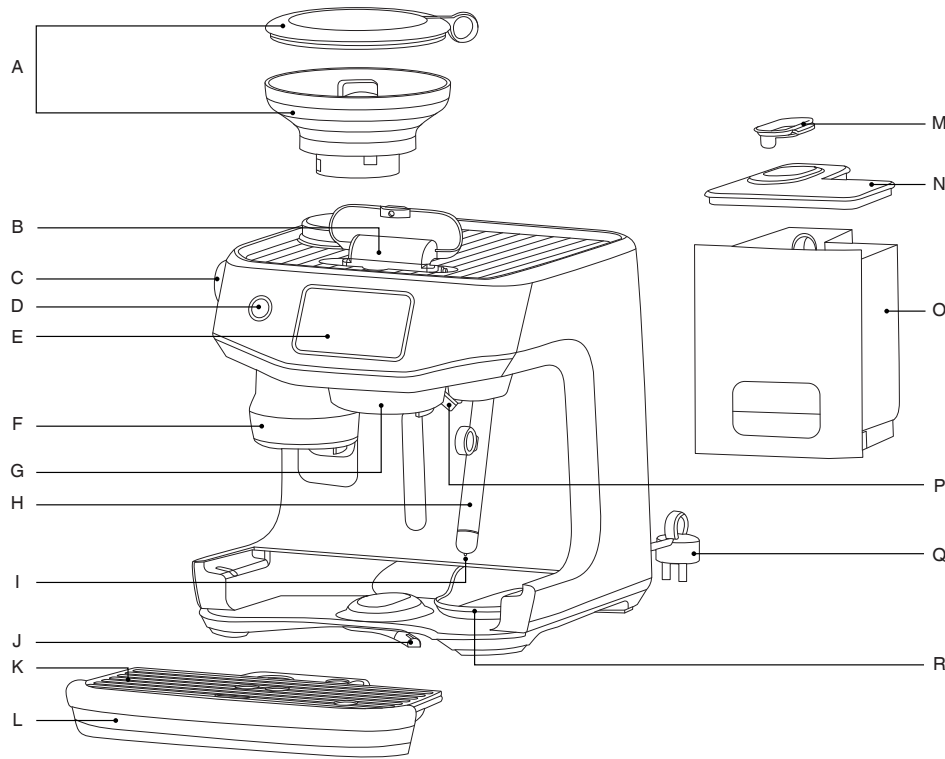

- A. 340g bean hopper
- B. Front top water fill
- C. Grind size adjustment dial
- D. Power button
- E. 5 inch colour touch screen
- F. Grind and tamp outlet
- G. Heated 58mm group head
- H. Auto MilQ™ steam wand
- I. Milk temperature sensor
- J. Front lever 3rd wheel
- K. Drip tray grill
- L. Drip tray
- M. Water tank mesh lid
- N. Water tank lid
- O. Water tank with latch lock
- P. Dedicated hot water outlet
- Q. Power cord (0.9 m) with storage
- R. Hidden tool storage tray

# ACCESSORIES

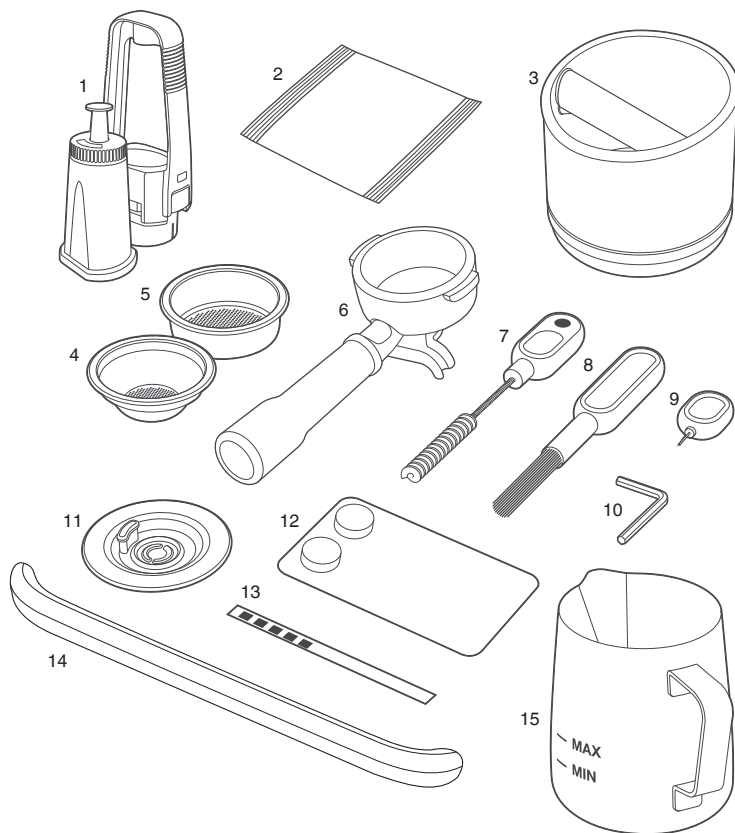

1. Water filter and filter holder
2. Descaling Powder
3. Knock Box™ 10
4. Single wall 1 Cup filter basket
5. Single wall 2 Cup filter basket\*
6. 58 mm Stainless Steel Portafilter
7. Grind outlet brush and tamp removal magnet
8. Cleaning brush
9. Cleaning tool for steam wand tip
10. Alley Key
11. Cleaning disc
12. Cleaning tablets
13. Water hardness strip
14. Drip tray guard (included with machines in colour only)
15. Stainless steel milk jug

\* Single wall 2 Cup filter basket comes installed in the portafilter.



# 1. UNBOXING

1.1

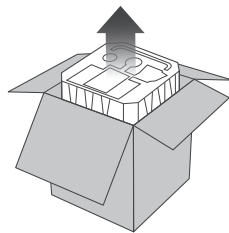

1.2

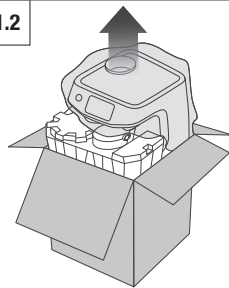

1.3

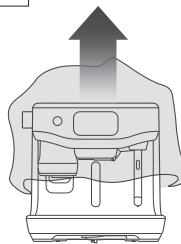

1.4



# 2. CARE & CLEANING

2.1

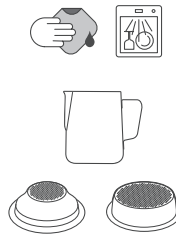
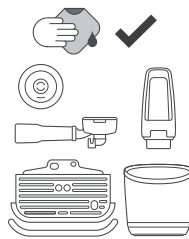
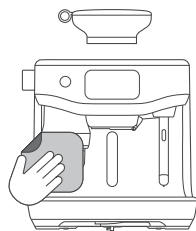

2.2

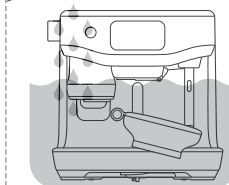

2.3

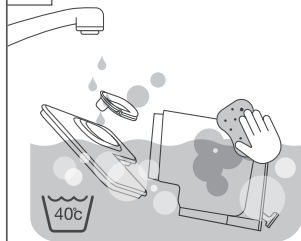

2.4

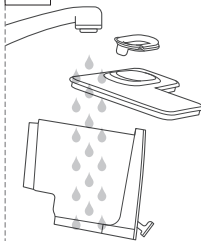

2.5

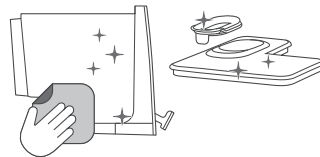

### 3. HOPPER ASSEMBLY

3.1

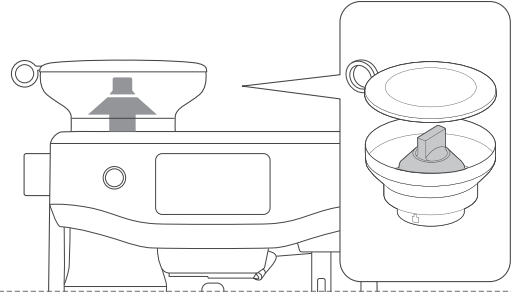

3.2

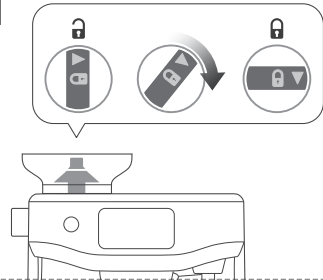

3.3

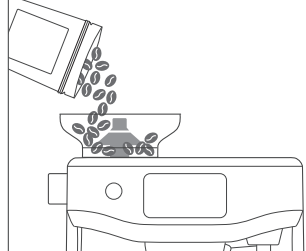

3.4

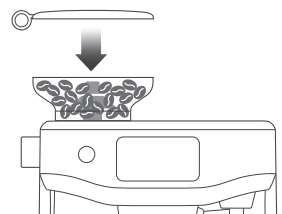

3.5

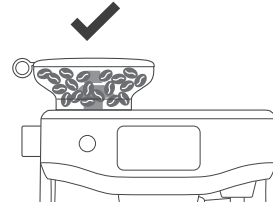

### 4. WATER FILTER ASSEMBLY

4.1

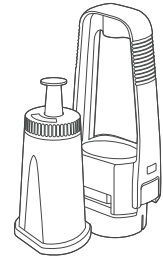

4.2

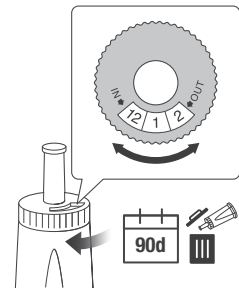

4.3



4.4

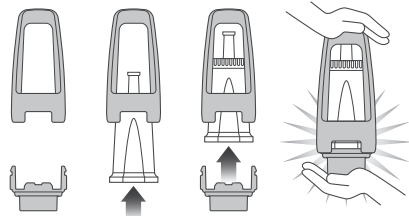

4.5

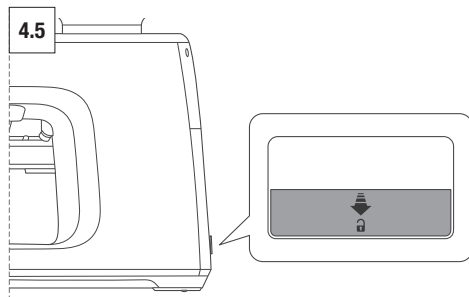

4.6

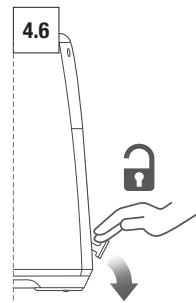

4.7

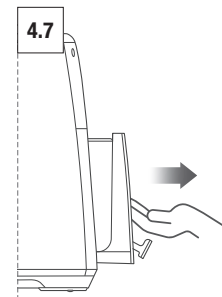

4.8

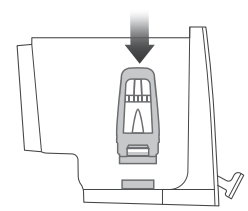

4.9

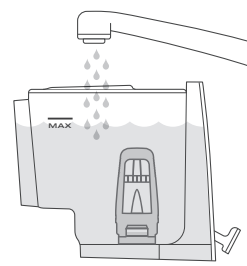
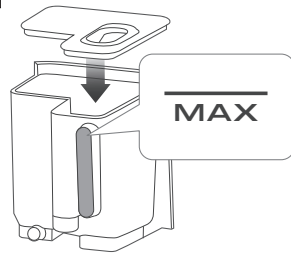

4.10

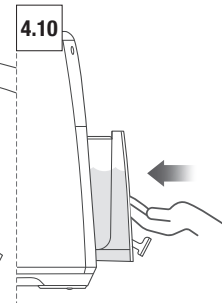

4.11

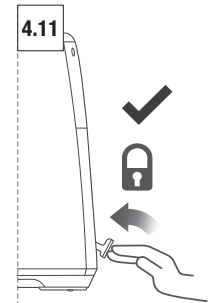

5.

## SETTING WATER HARDNESS

5.1

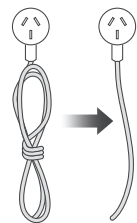

5.2

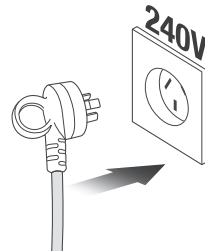

5.3

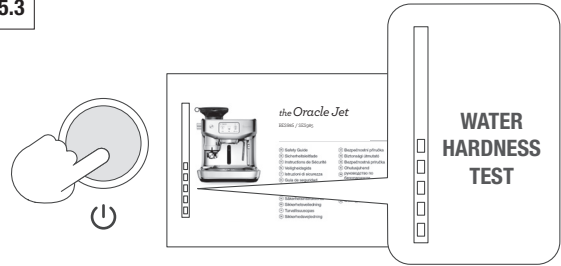

5.4



5.5



5.6



⌚ 1m

5.7

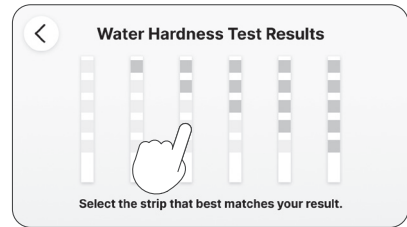

5.8



## 6. FIRST USE FLUSH CYCLE

6.1

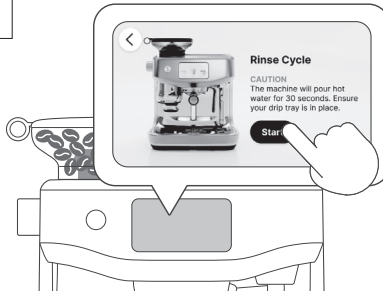

6.2



6.3

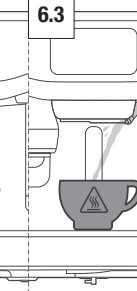

6.4

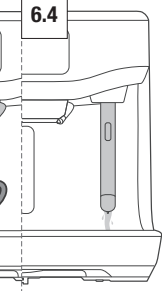

# 7. MAKE A COFFEE

7.1

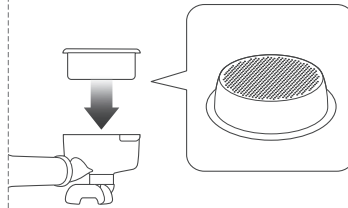

7.2

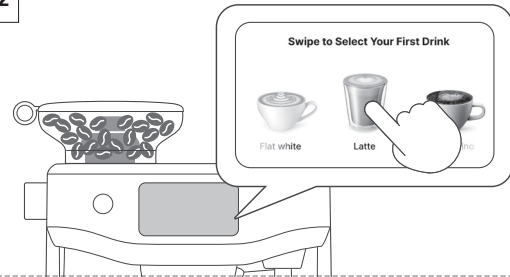

7.3

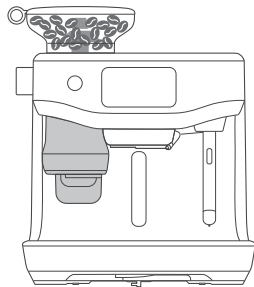

7.4

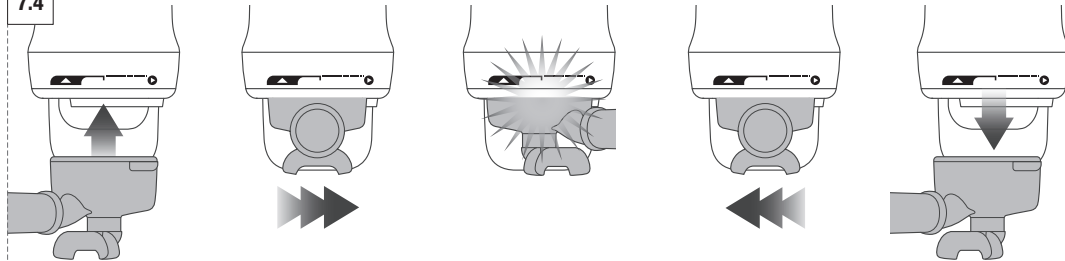

7.5

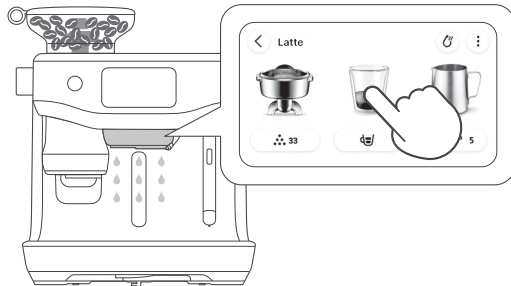

7.6

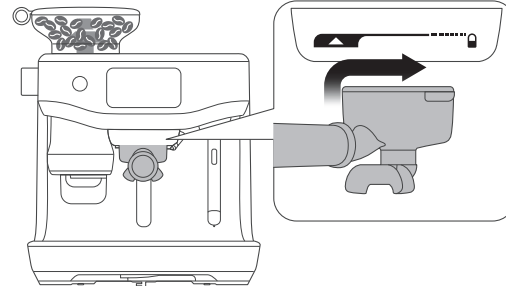

7.7

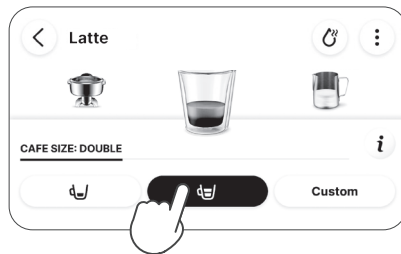

7.8

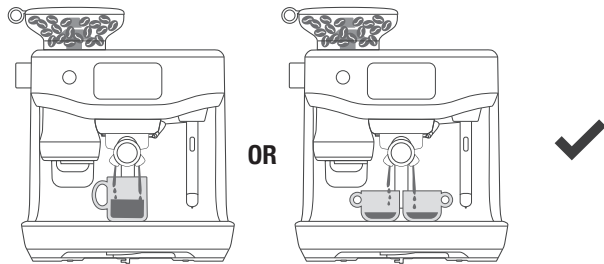

8.

# GRIND COARSER OR FINER

8.1

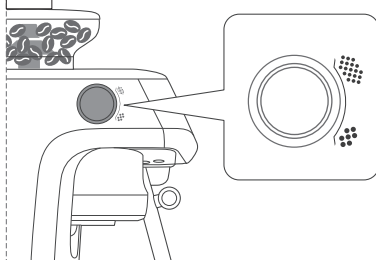

8.2

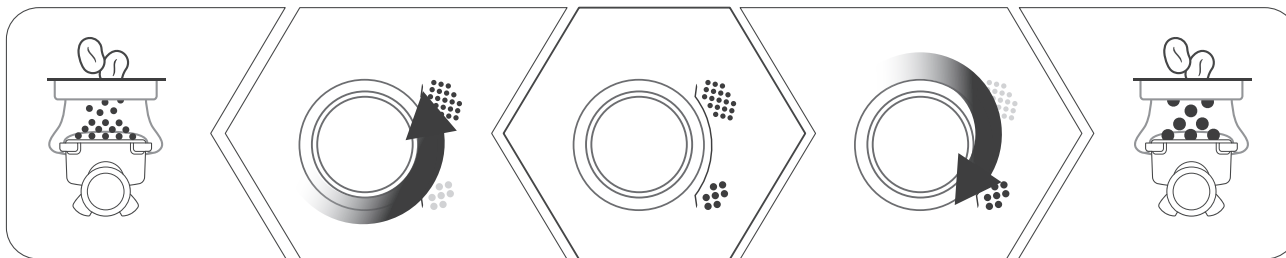

# 9.

## TEXTURE MILK



Breville-milktexturing-bes985

9.1

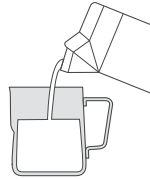

9.2



9.3

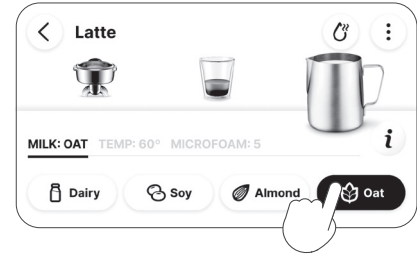

9.4

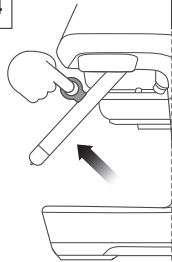

9.5

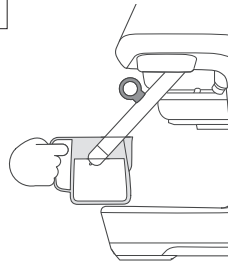

9.6

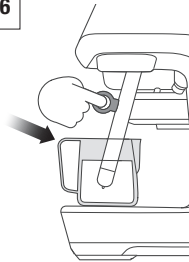

9.7

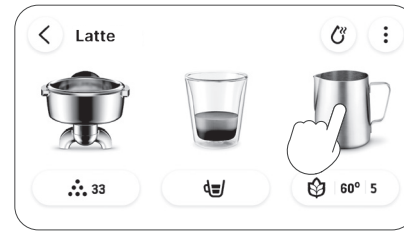

9.8

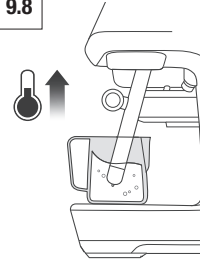

9.9

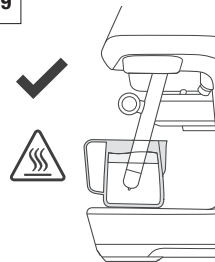

9.10

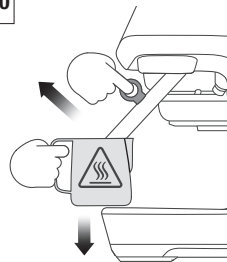

9.11

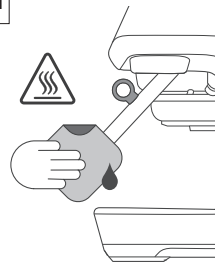

9.12

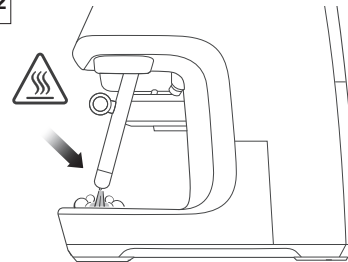



10.



QR202



For more information on:

- Cleaning • Troubleshooting
- Useful Tips and Warranty

Check out the website, visit [www.breville.com](http://www.breville.com)

## QR CODE LINKS



**Extraction Guide**



**Tutorial**



**Clean Steam Wand**



**Descale**

# NOTES

# NOTES

## Breville Service Center

### **Australian Customers**

**Phone:** 1300 139 798

**Web:** [www.breville.com](http://www.breville.com)

### **New Zealand Customers**

**Phone:** 0800 273 845

**Web:** [www.breville.com](http://www.breville.com)

# **Breville**<sup>®</sup>

Master Every Moment™

Breville, the Breville Logo, is a trademark of Breville Pty Ltd ("Breville") and Breville's products are distributed in Australia and New Zealand under license. Copyright Breville Pty. Ltd. 2023.

Due to continued product improvement, the products illustrated/photographed in this brochure may vary slightly from the actual product.